

voia®

Celebrating 50 years and beyond





The timeless purity of perfect form.

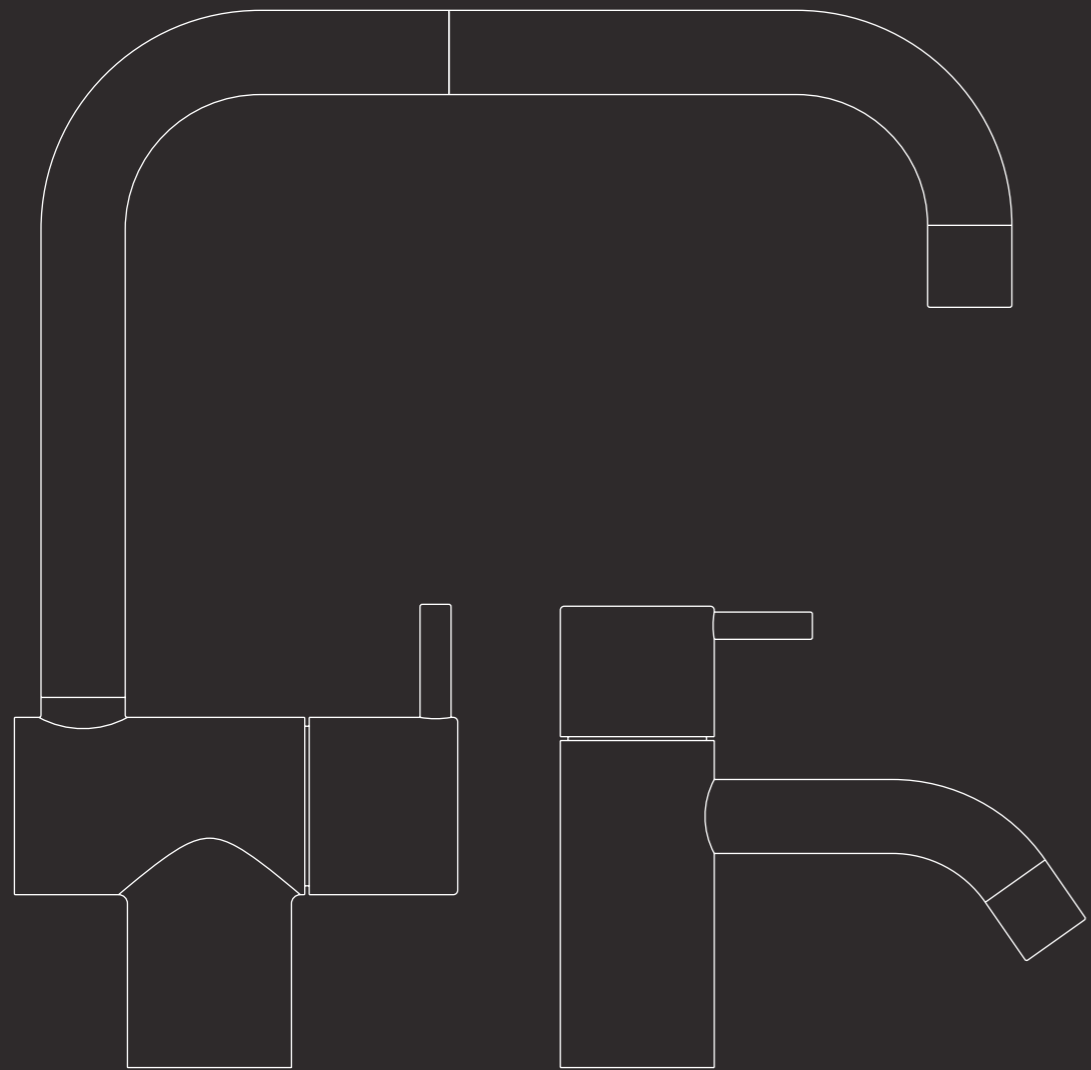

- 4 The original modern tap
- 12 History of craft
- 14 Form and function
- 22 Infinite possibilities
- 30 The home of VOLA
- 40 Water and wellness
- 48 Life cycle
- 58 Always evolving

In 1968, VOLA made the original modern-day tap, pioneering an iconic design that has remained classic, timeless and desirable ever since.



# The original modern tap

Since its first collection in 1968, VOLA has exemplified design excellence. The collaboration between VOLA owner Verner Overgaard and architect Arne Jacobsen combined form and function, craft and modularity, to create a timeless design ethos.

Their new, built-in tap concept attracted instant international acclaim. With its circular and linear forms and revolutionary hidden plumbing, the world's first fully integrated single lever mixer tap changed bathroom design forever.

New products followed, all of which were founded on Jacobsen's original principles of purity of design, quality of materials and integrity of manufacture. The modular system ensured that every product was flexible as well as functional. To this day, each product is made to order at the VOLA factory in Horsens, Denmark, crafted using advanced metalworking techniques and finished by hand.

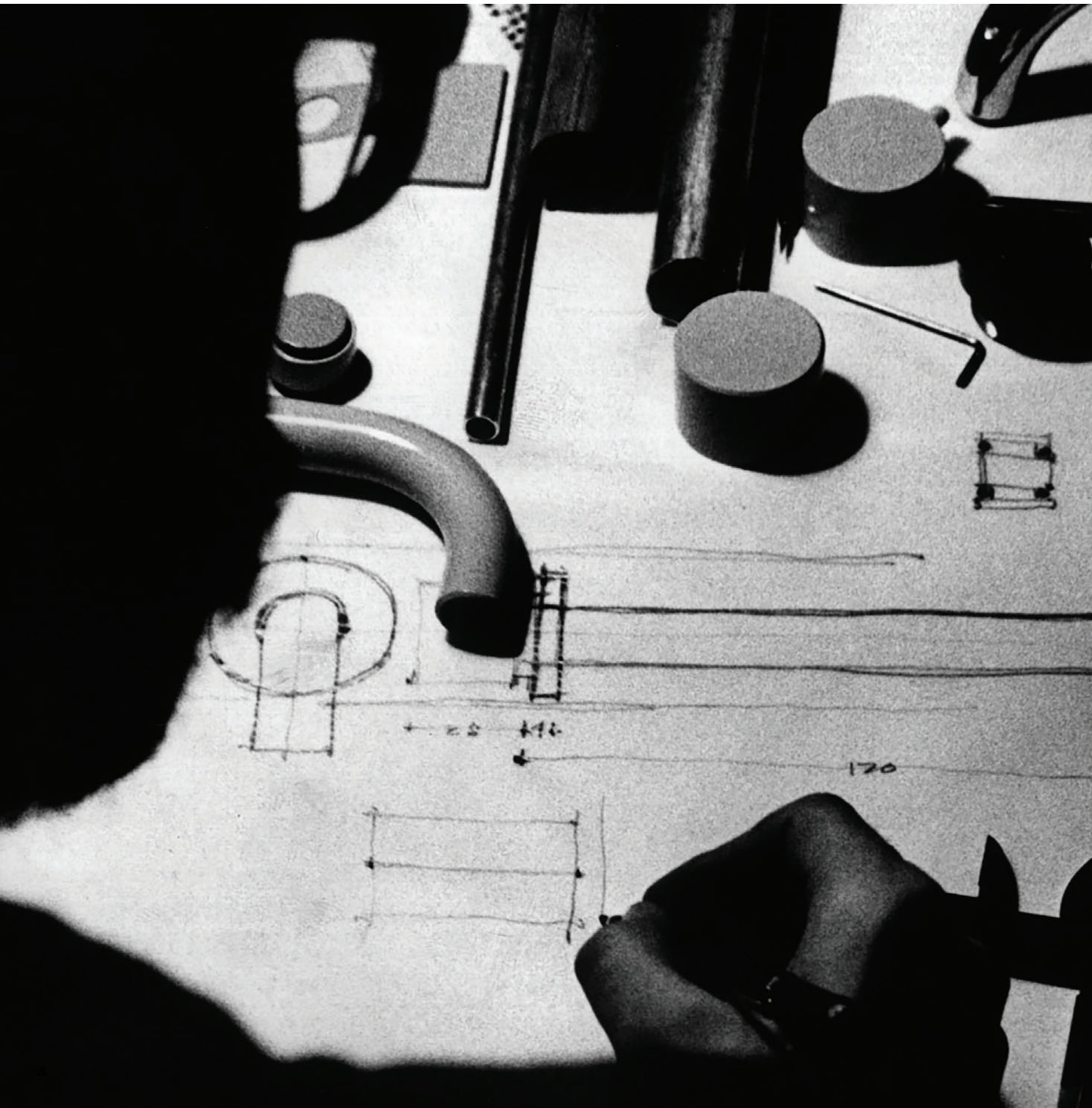

The first VOLA mixer tap, the 111, is the essence of the pared back form, a circle within a circle, bisected by a simple line.

Opposite Teit Weylandt with 111 plans.  
Top right Arne Jacobsen 1968.  
Above The original 111 designed in 1968.  
Bottom left First prototype of the single lever mixer tap.  
Bottom right An original drawing from 1968.

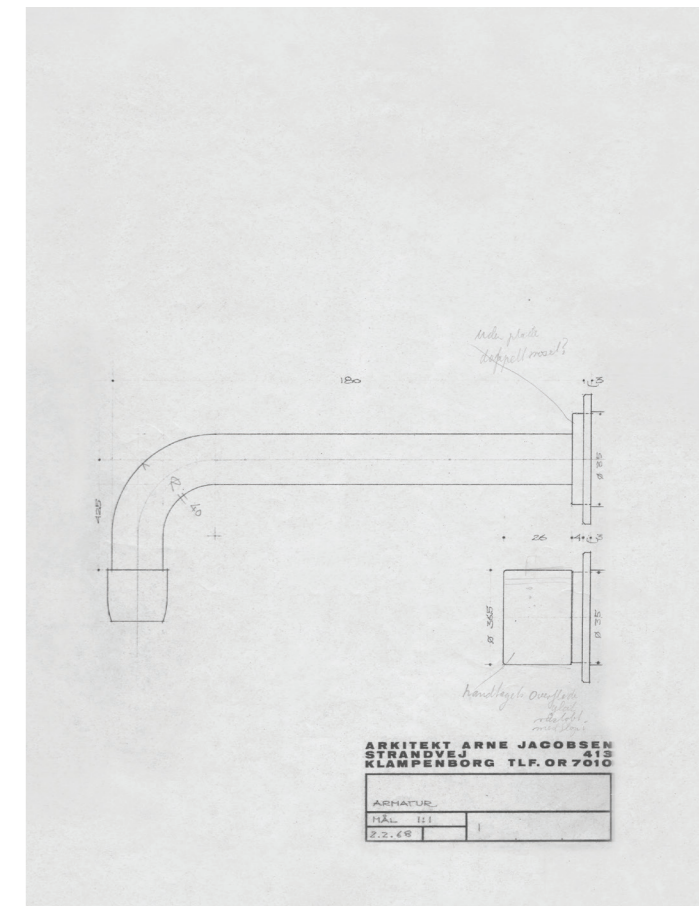



"Design classics are proof of the lasting values of good design"

Carsten Overgaard



VOLA products have remained elegant, efficient and contemporary since the birth of the 111. As VOLA celebrates its half century, its products still exemplify the pure simplicity of Jacobsen's first designs.

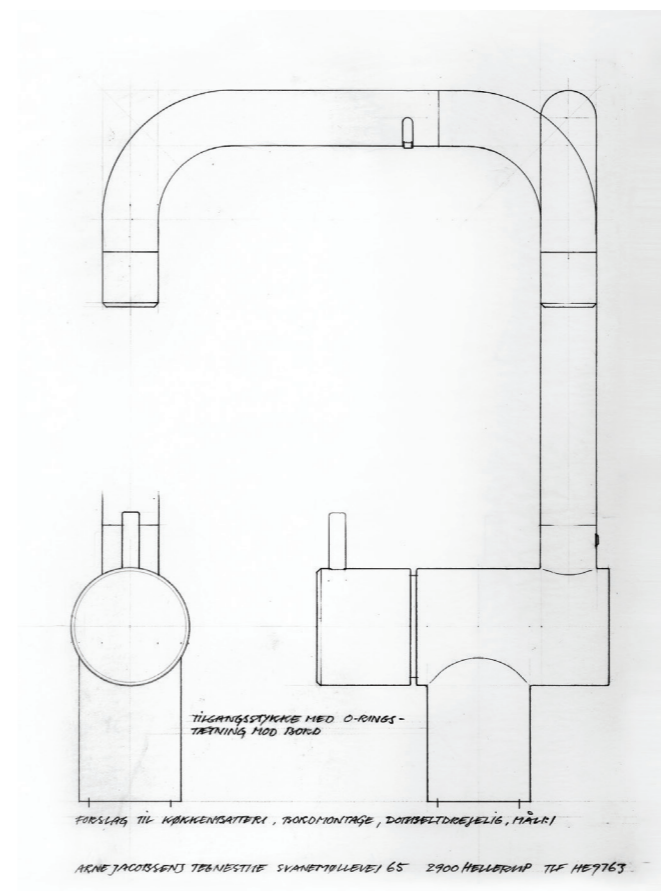

The KV1 is iconic, an architectural composition of subtle curves and precise junctions that represent the perfect intersection of craft and technology.

Opposite The original KV1.  
Above Verner Overgaard with KV1.  
Left The original KV1 drawing.



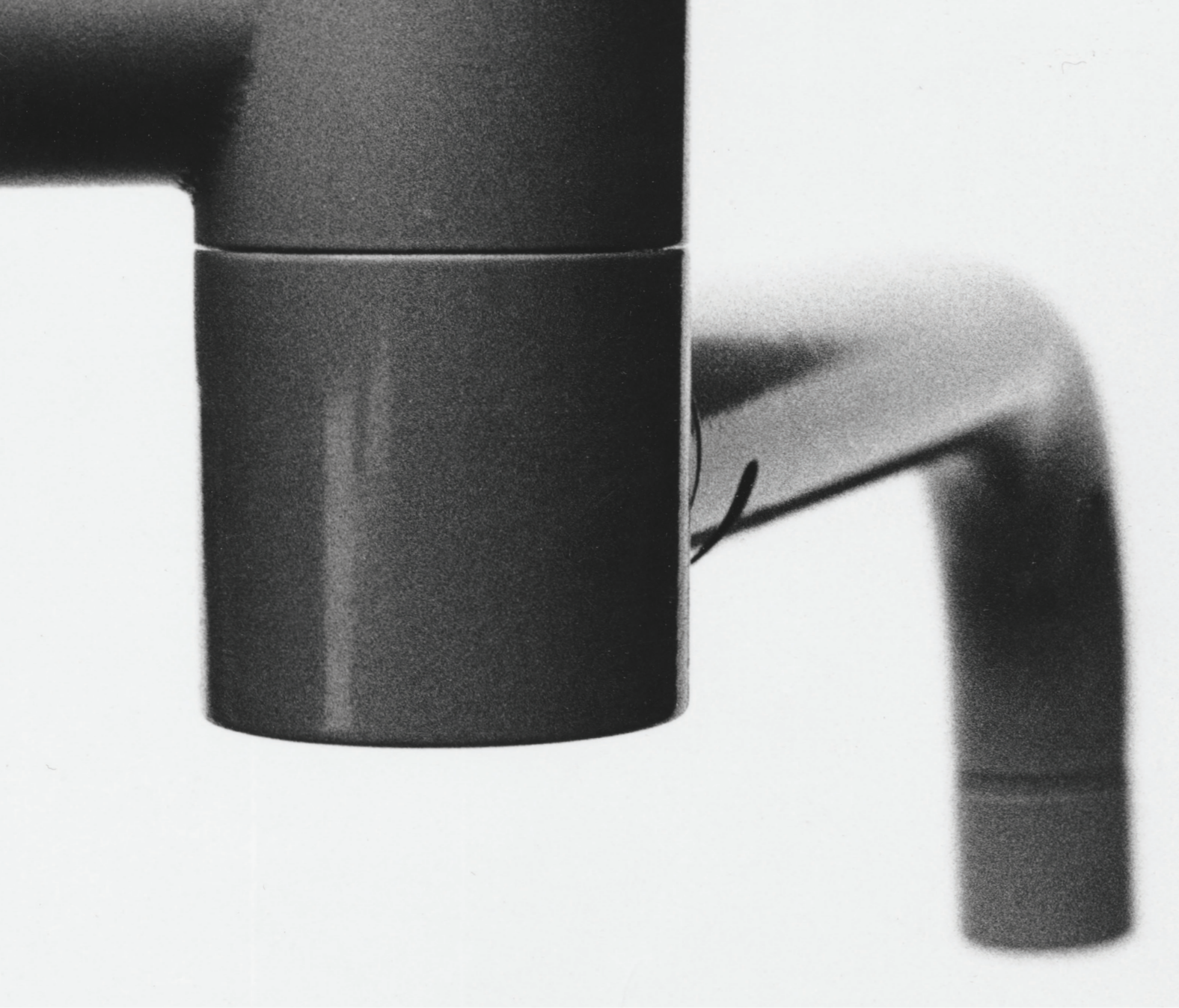

Opposite 111 family photographed by Morten Bo.

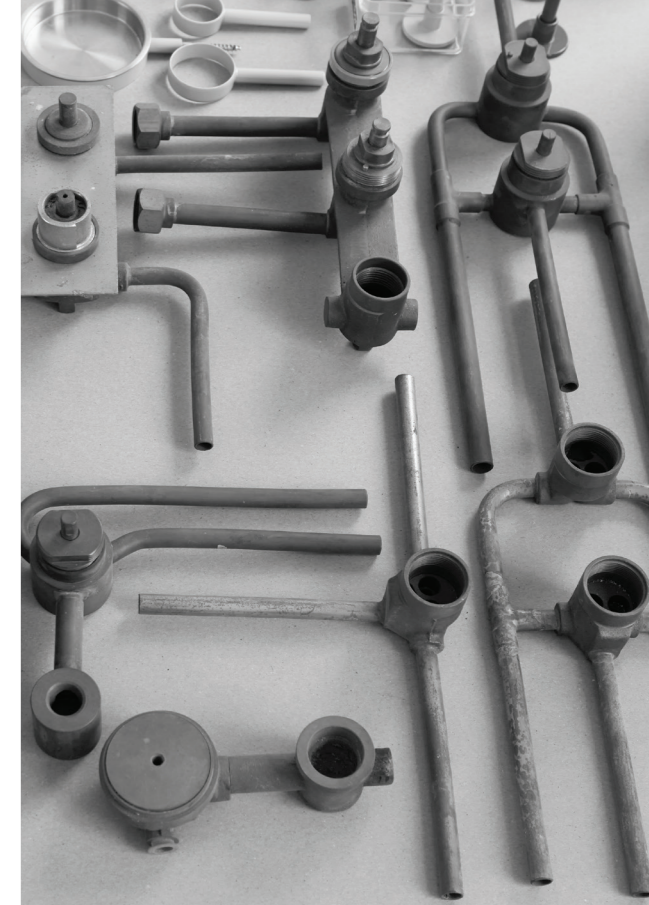
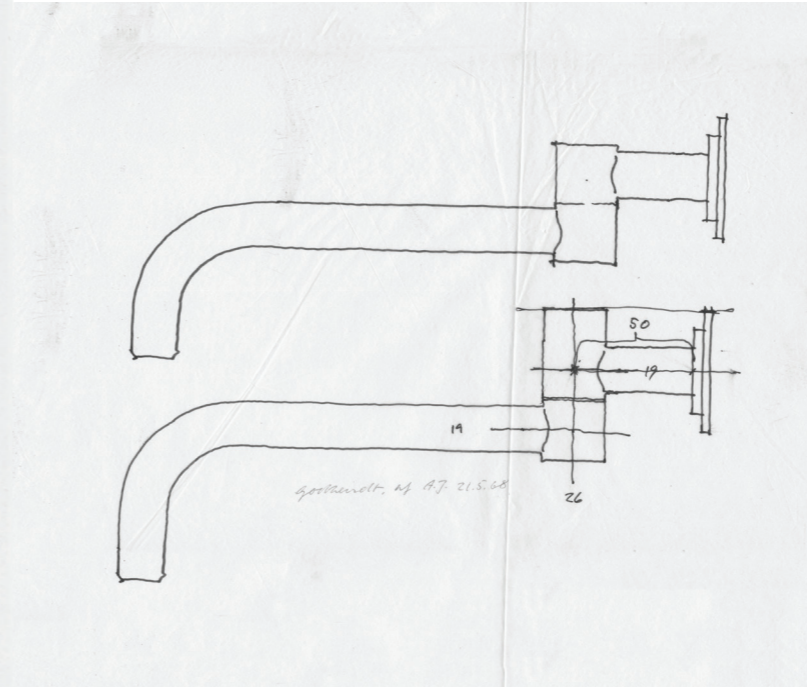

During 1968 hundreds of prototypes were created for the original 111 and HV1 taps.

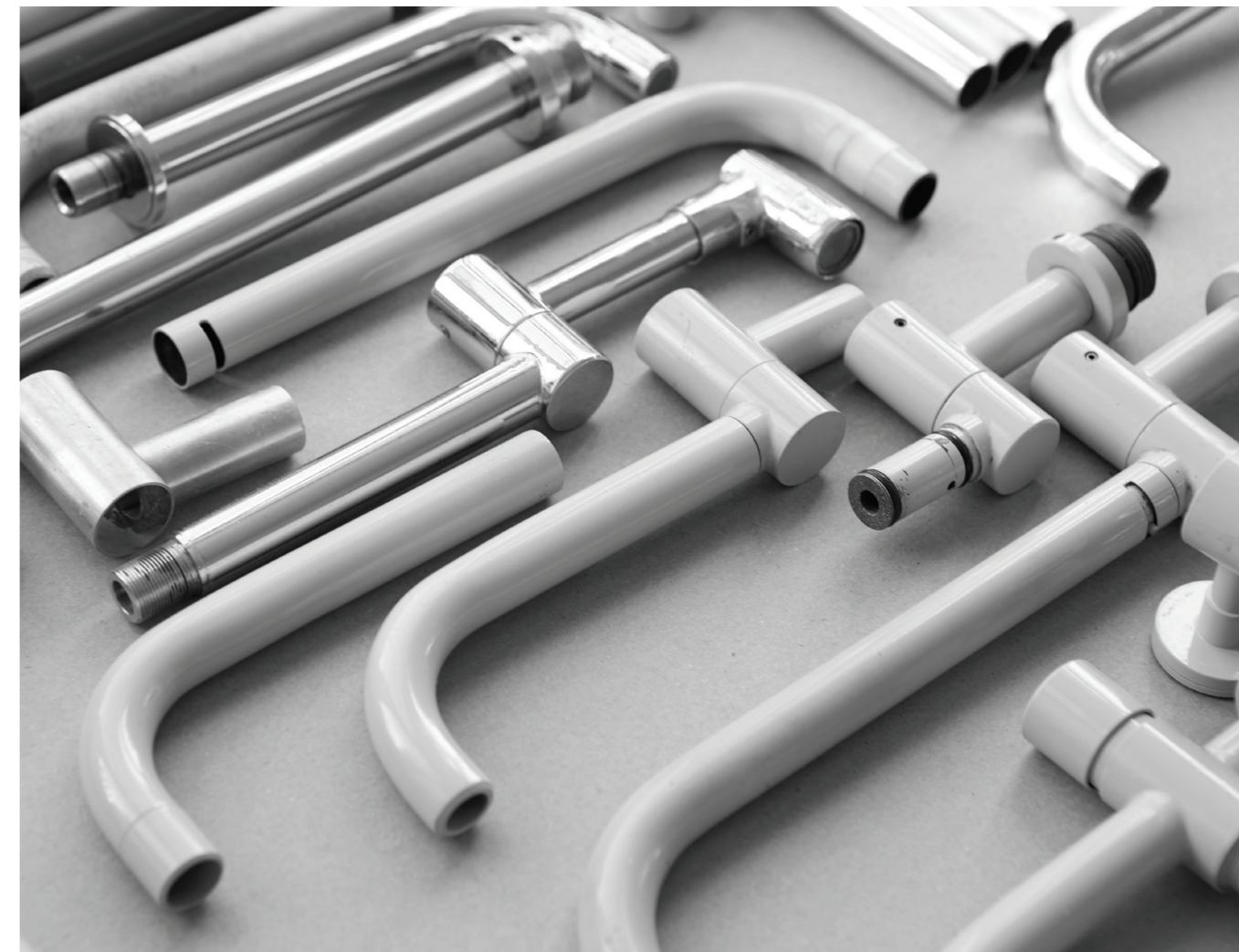
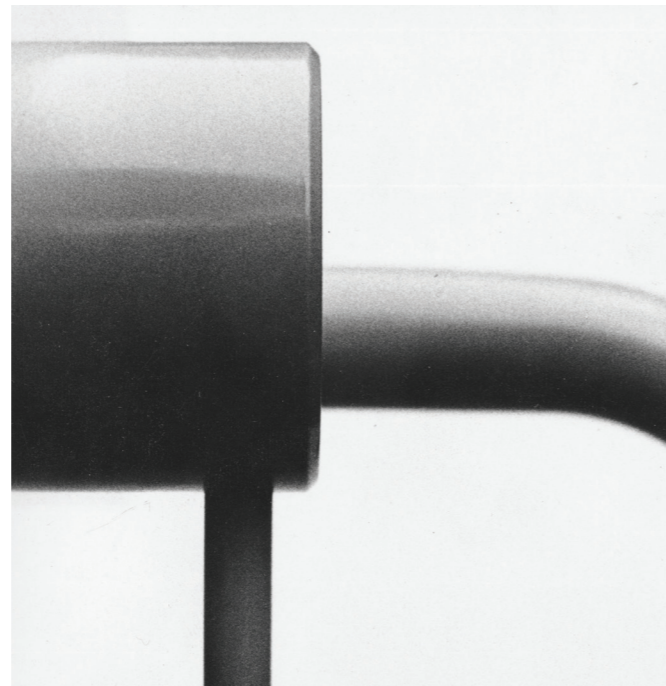
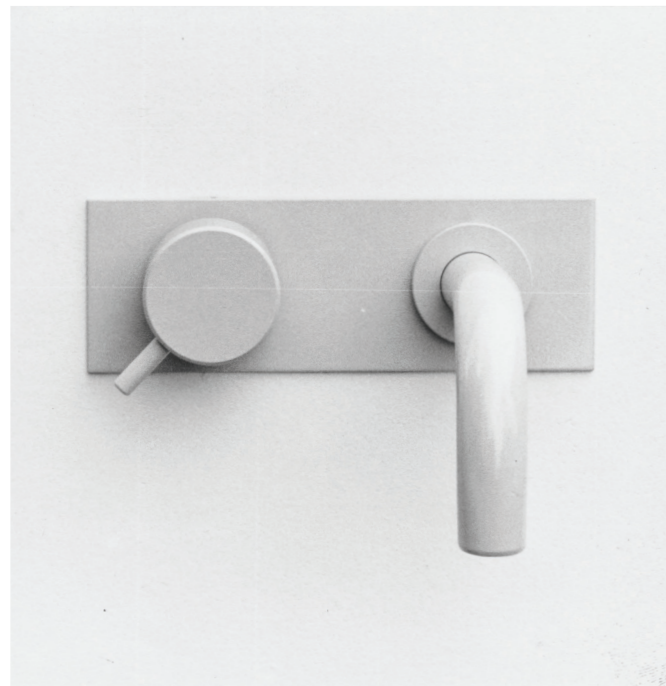



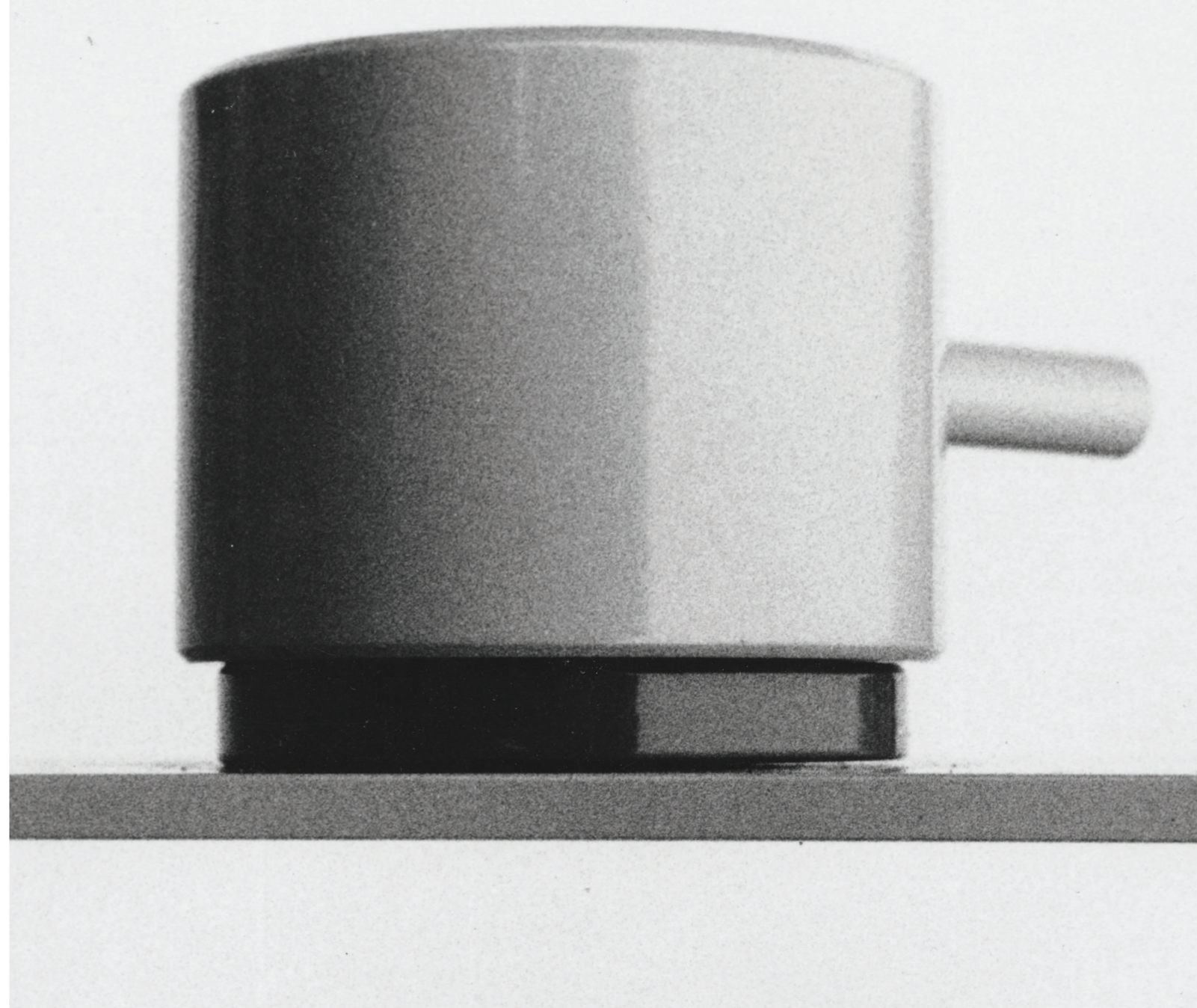
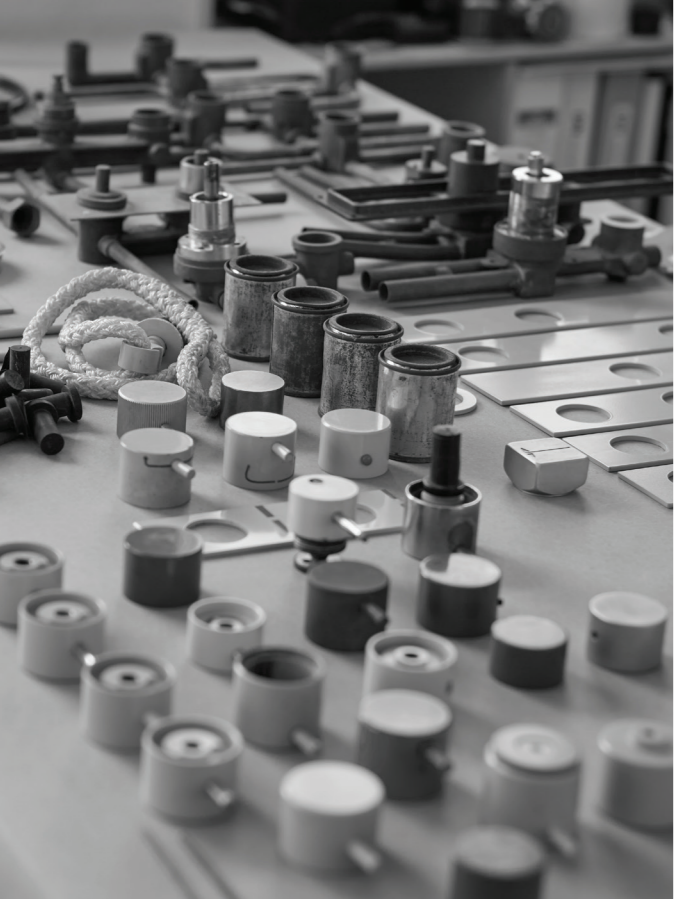

Opposite Iconic handle details  
photographed by Morten Bo.

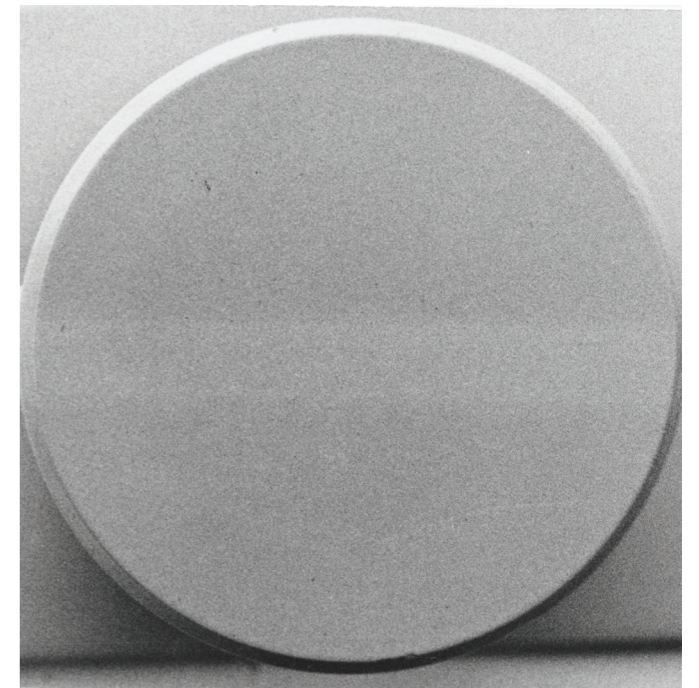
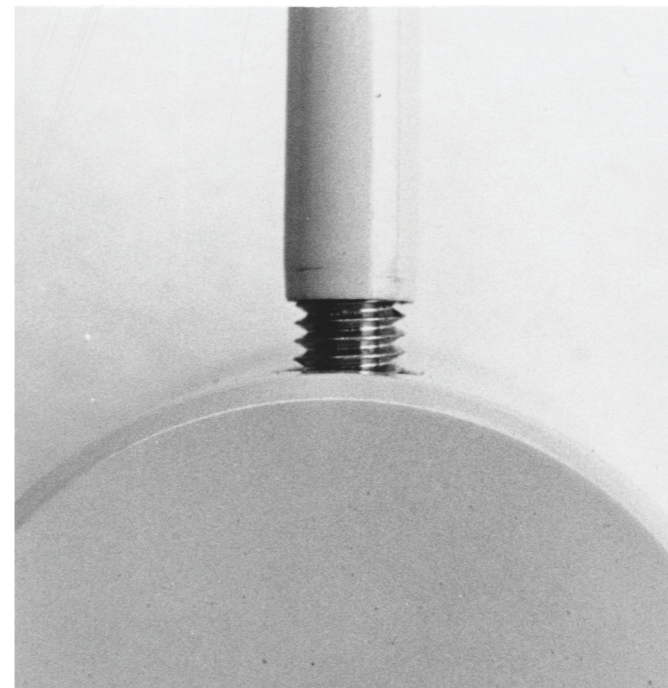
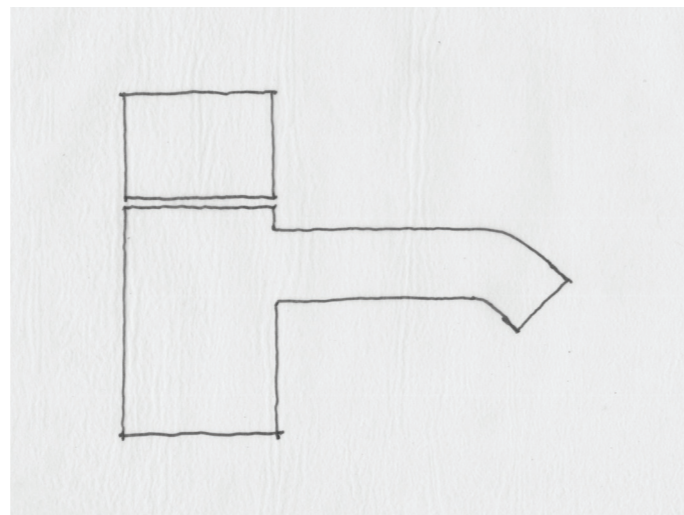



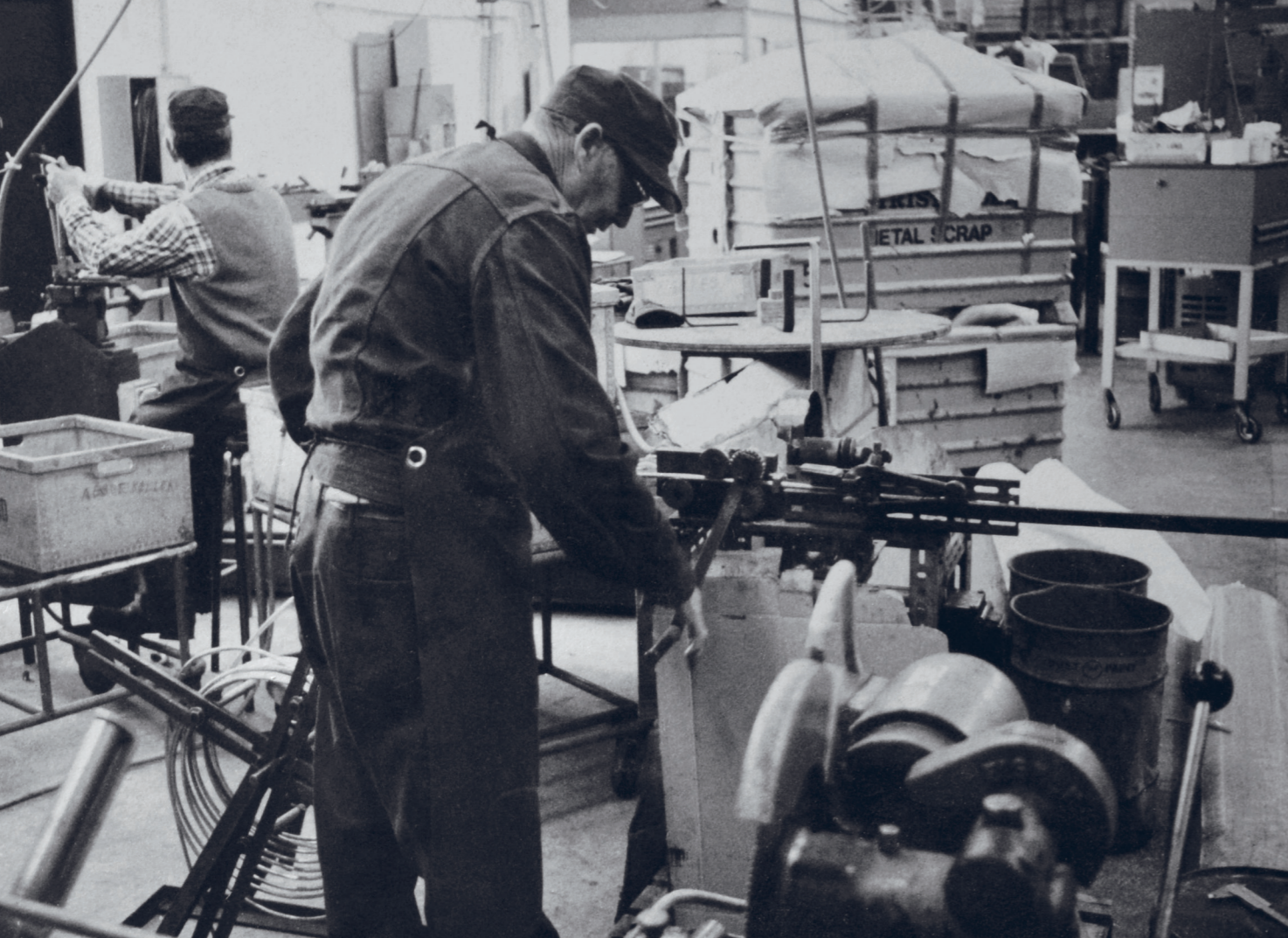

From its earliest days, VOLA has valued the importance of craftsmanship and hand-made processes.





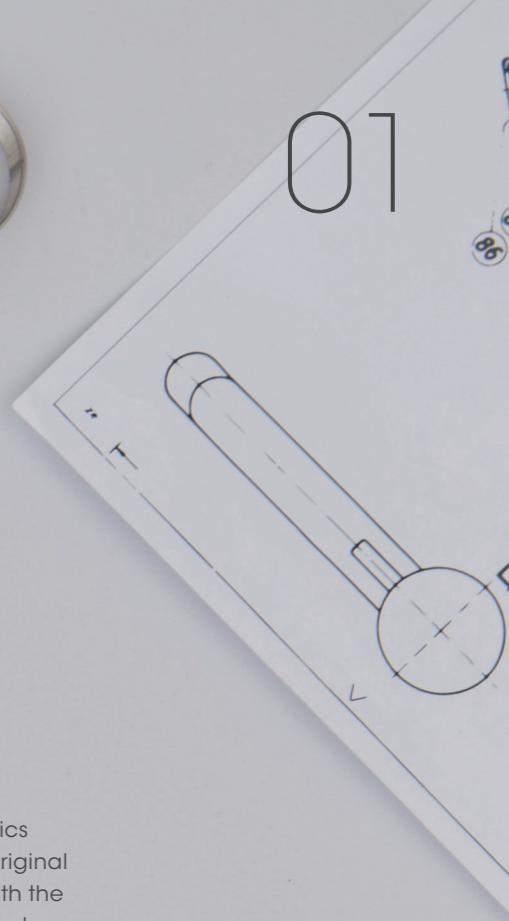
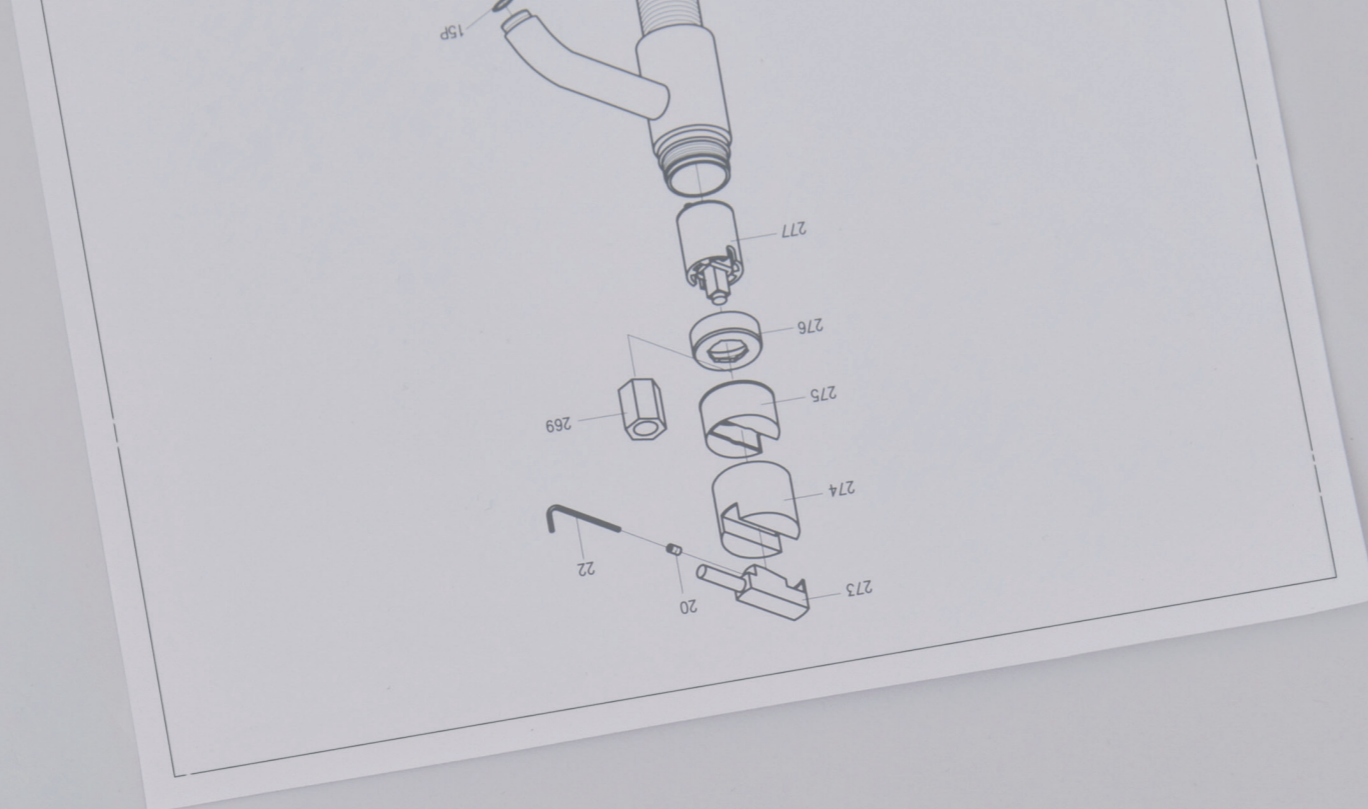

## Form and function

Today, the original VOLA products are celebrated classics unchanged for 50 years - a true testament to Jacobsen's original principles and designs. VOLA continues its conversation with the lineage of Danish design, exploring pure forms and geometry through circles, cylinders and lines.





VOLA has always demonstrated an intimate understanding of proportion and shape, using geometrically precise circular and cylindrical forms as the building blocks for its products.

**Below** The original HV1, designed and crafted in 1968, is a masterpiece of simplicity.

**Opposite** 590H one-handle mixer with swivel spout, in black (from the Exclusive Colour Series).







The ancient relationships between life and landscape, culture and environment, have inspired generations of Denmark's designers and architects.



Left Viking fort, Fyrkat, Denmark.  
Above Infinity Bridge, Aarhus, Denmark.





The collaboration between Overgaard and Jacobsen created a geometric, minimal approach that set the stage for 50 years of stylistic invention by VOLA. One of Jacobsen's first products, the HV1 tap of 1968, is defined by the effortless simplicity of the intersecting circle and cylinder.

Above Detail of handle production.  
Opposite Geometric forms within VOLA.







## Infinite possibilities

Like every VOLA product, the iconic 111 range is made to order, crafted at the VOLA factory in Horsens, Denmark. The 111 range is a testament to a modular design system of infinite possibilities that can be endlessly customised for any application.





The 111 family of handles, plates and spouts is the ultimate contemporary product, a truly modular system of design. VOLA embraces continuity and interchangeability – parts are still available for every product ever made.

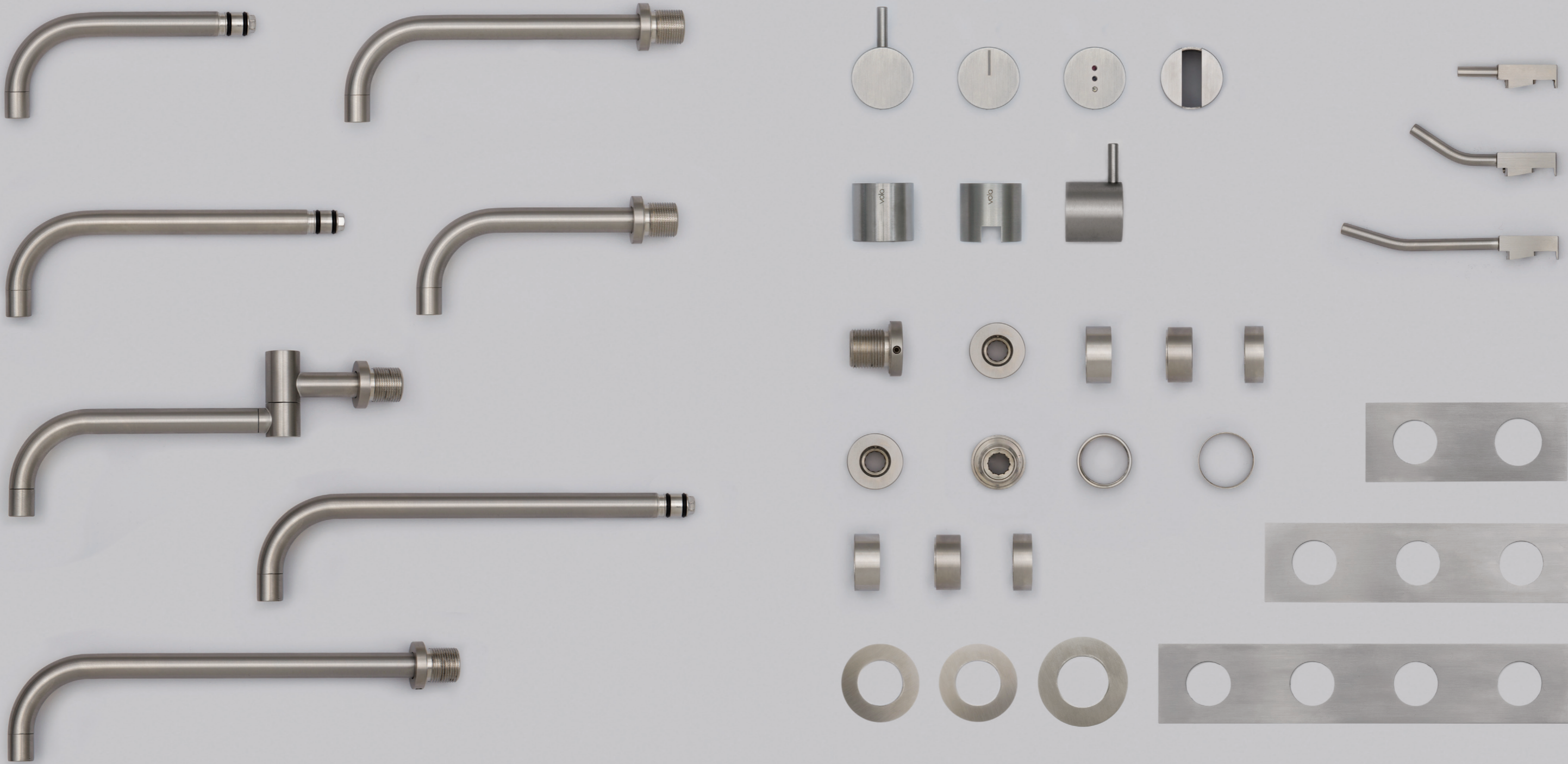





Every VOLA product is available in a range of colours and finishes, giving individuals almost unlimited creative scope.







The 111 defines the VOLA approach; a product that brings individual inspiration to life. Products are made to order and are ideal for a vast number of applications, from private homes to offices and even super-yachts.

**Opposite** 111 one-handle, build-in mixer with fixed spout and A63 waste fitting, in brushed copper (from the Exclusive Colour Series).





## The home of VOLA

VOLA is designed and produced in Horsens, Denmark, a proud home to generations of experience in craft, design and architecture. The factory is a place where methods old and new blend, where tradition and innovation live side by side.





The people behind the products,  
the machinists, craftspeople and  
designers are the heart of VOLA.

The VOLA family spans all ages. It is  
about togetherness and a shared  
understanding of what it means to be  
Danish – in the past, present and future.



Jonas Skipper Nielsen  
Metal worker





VOLA has nurtured a dedicated team, from machinists to designers, managers to metalworkers, all of whom take pride in upholding the VOLA reputation for excellence.





VOLA brings life and craft into the heart of the home. The VOLA KV1 is the most iconic of all the products made by the VOLA family.



KV1 One-handle mixer with double swivel spout, in natural brass.





Next to the factory in Horsens, is the VOLA Academy, a place to meet and to learn. Here, VOLA employees and international specialists learn about the company and its products and share knowledge and ideas.





## Water and wellness

Water is a vital element of life and a key part of wellness. This relationship has always been at the core of VOLA design. Architects and designers choose VOLA for the emphasis that its products place on purity and pleasure.





Water is not only essential, it nourishes the soul. Delivering the precise, controlled flow of water has been a core VOLA value for 50 years.





The modern bathroom should be a place of retreat and relaxation from the stresses of life. VOLA products help architects and designers to create holistic bathing spaces that harmonise with their environments.

**FS1** A free-standing bath mixer with handshower, in brushed stainless steel.





Precision of water flow, responsive control and the careful, silent blending of water and air create perfect bathing experiences.



**090E** Swivel bath spout in brushed stainless steel.



## Life cycle

Great design is not just about aesthetics, it is also the precision of craft and the use of high quality materials. By using only the purest stainless steel and brass, VOLA ensures that 100% of the waste produced is recovered and recycled. VOLA has always taken great pride in its environmental responsibilities. Products last for generations - well beyond a standard life cycle.







The VOLA 060 Round-head shower is a pure, essential form. To ensure the shower retains its perfect cylindrical shape, every shower head is made from a single disk sliced from a solid 600 kg cylinder of brass.



The inside is carved out, returned to the foundry and recycled into new cylinders. Ultimately, each cylinder of brass or stainless steel will yield 386 Round-head showers.



As Denmark has few natural resources, sustainability has been fundamental from the earliest days. This has contributed to the Danish focus on minimalism, enduring craft and pure design that continue to define the VOLA approach.





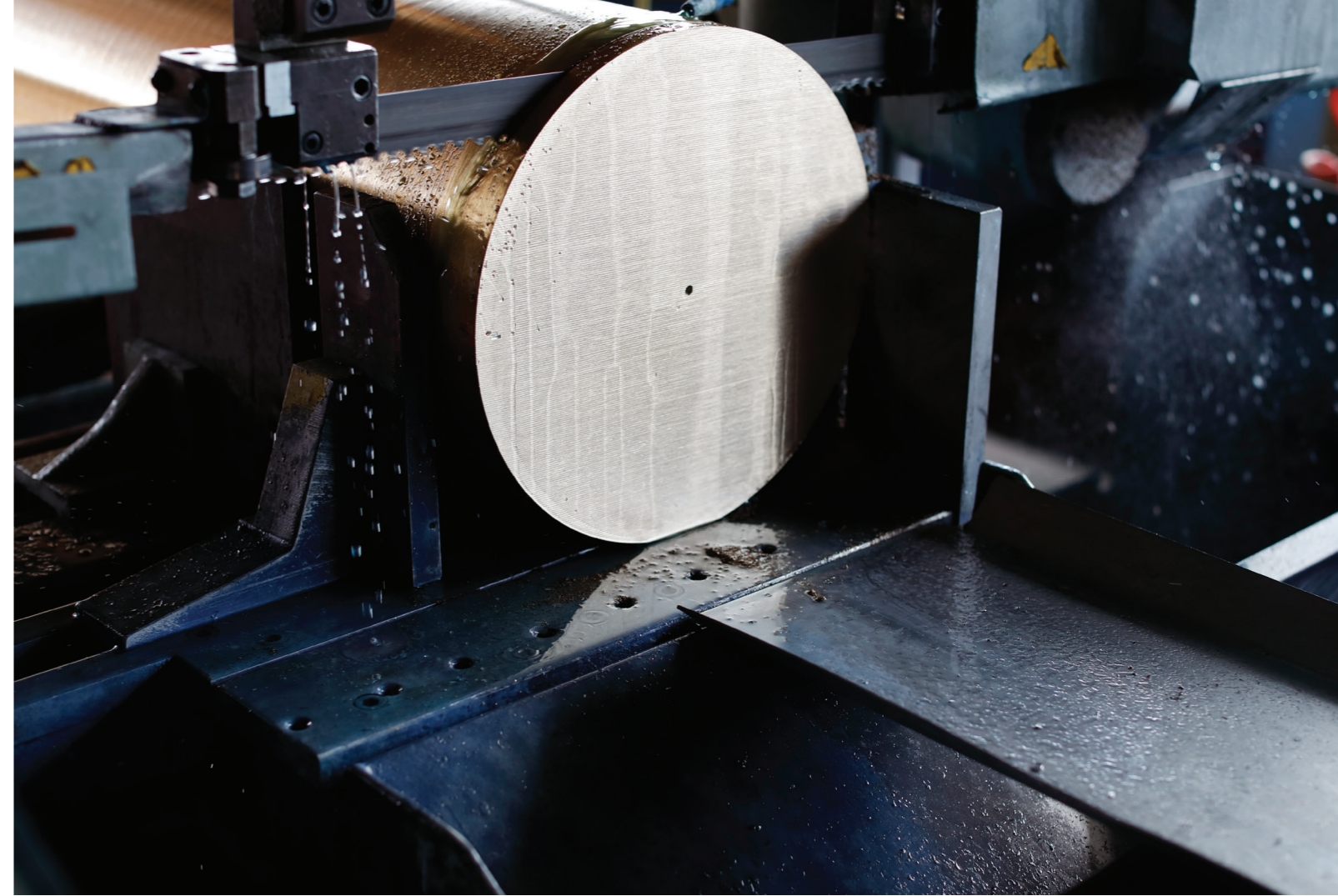

Quality control is paramount at every stage of the production process, as well as environmental responsibility; high levels of recycling are paired with low levels of energy use. The iconic 060 Round-head shower upholds the values established in 1968 by Overgaard and Jacobsen.





As well as making products that last for generations, water conservation is equally important to the VOLA commitment to sustainability. The Round-head shower can deliver as little as 15 litres of water per minute at 3 bar pressure.



060 Wall-mounted Round-head shower, in brushed stainless steel.





## Always evolving

Consistency is driven by logic, but innovation is driven by passion. From Arne Jacobsen's very first design, VOLA has used modularity as a way of delivering consistency, compatibility and flexibility. But VOLA also understands the need to create something new; to go on a new journey and to tell a new story. VOLA is always evolving.



Evolution goes hand in hand with continuity. From the very first to the most recent product, VOLA is committed to innovation of design and function. The T39 modular heated towel rail can be tailored to each installation, configuring (up to 20 bars) and spacing (from 100-300 mm between bars) to fit any environment.



2111C One-handle build-in mixer with fixed spout, in brushed copper (from the Exclusive Colour Series).

T39 Build-in modular heated towel rail, in brushed copper (from the Exclusive Colour Series).



The pioneering Danish spirit is the heartbeat of VOLA, evolving its approach to design, manufacturing and wellness. This innovative curiosity will continue to lead VOLA into the future.





The VOLA modular design system is almost infinitely flexible, creating possibilities for seamless interior schemes that are 100% VOLA.



T39 Shown above, build-in modular heated towel rail, in chrome.  
SC10 One-handle mixer with double swivel spout and hand shower in chrome.



While respecting its design heritage, VOLA continues to invest in new product development. Even revolutionary designs can benefit from technology-led evolution.

Five decades of expert knowledge, design and craft skills have come together to create and innovate products often imitated, but never equalled. As well as designing the original modern-day tap, VOLA is also a multi award-winning brand that has brought modern Danish design to contemporary homes around the world.

VOLA is proud to represent the best of international design and will continue to make its products in Denmark using the highest quality raw materials. Committed to sustainability, education and authenticity, VOLA continues to evolve.





**Design and production**  
Identity Ltd, London

**Photography**

Nick David  
Roger Davies  
Jonathan Gregson  
Brooke Holm  
Søren Rønholt  
Alex Wilson

**VOLA A/S**  
Lunavej 2  
DK-8700 Horsens  
Denmark  
Tel: +45 7023 5500  
Fax: +45 7023 5511  
sales@vola.dk  
www.vola.com



**AUSTRALIA**

VOLA Design Pty. Ltd.  
Tel: +61 402 372 480  
sales@vola.com.au

Candana Design  
120 Edgecliff Road  
AU-2025 Woollahra  
Tel: +61 2 9389 8631  
marc@candana.com.au  
www.candana.com.au

Elite Bathware & Tiles  
948 Stanley Street  
AU-4169 East Brisbane  
Tel: +61 7 3391 1399  
Fax: +61 7 3391 1059  
michele@elitebathware.com.au  
www.elitebathware.com.au

Mary Noall Ply Ltd  
Canterbury Road  
AU-3206 Middle Park  
Tel: +61 3 9690 1327  
Fax: +61 3 9699 4282  
nick@marynoall.com.au  
www.marynoall.com.au

Sea of White  
205 Main Street  
AU-6017 Osborne Park  
Tel: +61 8 9344 1500  
Fax: +61 8 9344 1499  
info@seaofwhite.com.au  
www.seaofwhite.com.au

Sydney Tap and Bathroomware  
252 Mitchell Road  
AU-2015 Alexandria  
Tel: +61 2 9560 4628  
Fax: +61 2 9318 1127  
sales@sydneybathroomware.com.au  
www.sydneybathroomware.com.au

**BELGIË**

VOLA byba  
Tour & Taxis  
Havenlaan 86C  
1000 - Brussels  
Tel: 02 465 96 00  
Fax: 02 426 48 96  
sales@vola.be  
www.vola.be

**CANADA**

Ginger's Bath  
95 Ronald Ave.  
Toronto, Ontario  
M6B 4L9  
Tel: 416-787-1787  
Fax: 416-787-1748  
info@elte.com  
www.elte.com

**ČESKÁ REPUBLIKA**

LAVARE, s.r.o.  
Bohunická 576/52  
CZ - 619 00 Brno  
Tel: +420 777 969 999  
korosi@lavare.cz  
www.lavare.cz

**CHINA**

VOLA Showroom  
1f, No. 511  
Jiangning Road  
Jingan District  
Shanghai 200041  
Tel: +86 183 0190 6509  
sales@vola.cn  
www.vola.com

Euro-tech Industrial Company Limited  
Shop 05, No. 600  
Shaaxi Road North,  
Jing An District  
Shanghai 200041.  
Tel: +86 21-61767550  
Fax: +86 21-61767552

Badeluxe Trading Limited  
Room 8012  
Tongguang Building  
No.12 Agriculture Exhibition Center  
South Road  
Chaoyang District  
Beijing, 100026, P.R.C.  
Tel: +86 010 6522 7033  
Fax: +86 010 6526 1373  
info@badeluxe.com

Shanghai Tech Pro  
Office and Showroom  
Building 2 Dream Wharf  
1029 South Zhongshan Road  
Huangpu District  
Shanghai 200011  
Tel: (8621) 6419 6704  
Fax: (8621) 6461 1432  
shanghai@viahk.biz

**DANMARK**

VOLA A/S  
Lunavej 2  
8700 Horsens  
Tel: +45 70 23 55 00  
sales@vola.dk  
www.vola.com

Pakhus 48  
Klubbiensvej 22  
2150 Nordhavn  
Tel.: +45 7022 4570  
sales@vola.dk  
www.vola.com

**DEUTSCHLAND**

VOLA GmbH  
Schwanthaler Straße 75A  
80336 München  
Tel: 089/599959-0  
Fax: 089/599959-90  
vola@vola.de  
www.vola.de

**ESPAÑA**

DEE  
Ctra. Dosrius, 69-3º-2º  
E-08440 Cardedeu  
Barcelona  
Tel: +34 972 10 55 35  
Fax: +34 931 13 85 85  
iconico@iconico.es  
www.vola.es

**ESTONIA**

Hals Interiors OÜ  
Kadaka tee 42H  
12915 Tallinn  
Tel: +372 7151410  
Fax: +372 7151411  
hals@hals.ee  
www.hals.ee

**FRANCE**

sopha industries  
44, rue Blanche  
75009 Paris  
Tel: 01 42 81 25 85  
Fax: 01 40 16 45 18  
sopha@sopha.fr  
www.sopha.fr

**GREAT BRITAIN**

VOLA UK Ltd.  
Highfield House  
108 The Hawthorns  
Flihwick MK45 1FN  
Tel: 01525 720111  
Fax: 01525 720222  
sales@vola.co.uk  
www.vola.co.uk

VOLA Studio  
32-36 Great Portland Street  
London W1W 8QX  
Tel.: 020 7580 7722  
Fax: 020 7580 7733  
sales@vola.co.uk  
www.vola.co.uk

**HELLAS**

moda bagno s.a.  
50 Anapafseos Street  
Vrillissia 15 235, Athens  
Tel: 210 8036700  
Fax: 210 8049408  
Fax: 210 8046987  
info@modabagno.gr  
www.modabagno.gr

**HONG KONG**

VOLA Hong Kong  
Tel: +852 6388 9520  
joc@vola.com  
www.vola.com

H2O Pro Ltd.  
16/F First Commercial Building,  
33 Leighton Road  
Causeway Bay  
Tel: 852 2891 6860  
Fax: 852 2834 3029  
info@h2opro.com.hk  
www.ebon.com.hk

**ISLAND**

Tengi ehf.  
Smidjuvegur 76  
200 Kópavogur  
Tel: 414-1000  
Fax: 414-1001  
www.tengi.is

**ISRAEL**

Via Arkadia Ltd.  
7-9 Halechi street  
Bnei Brak 51200  
Tel: 972-3-9394666  
info@via-arkadia.co.il  
www.via-arkadia.co.il

**ITALIA**

RAPSEL International S.R.L.  
Via A. Volta, 13  
20019 SETTIMO MILANESE - MI  
Tel. 02 3355981  
Fax 02 33501306  
commerciale@rapselint.it  
www.rapsel.it

**KOREA**

E.L. System Co. Ltd.  
Jaemyoung B/D  
893-12  
Bangbae 1dong  
Secho-Gu  
Seoul  
Tel: 82-2-598-4517  
Fax: 82-2-521-3786

**KYPRIAKI DIMOKRATIA**

S.C. Nicolaidis Ltd  
3, Gregoriou Karekia str.  
Strovolos  
P.O. Box 21703  
1512 Nicosia  
Tel: 22 813 200  
Fax: 22 424 803  
info@oikia.com.cy

**LEBANON**

Geahchan Group  
Sin El Fil  
Geahchan Building  
Hayek Round About  
Beirut  
Tel: 01. 480 520  
Fax: 01. 496 607  
info@geahchangroup.com  
www.geahchangroup.com

**MEXICO**

Productos de Latón  
de Alta Calidad  
General Juan Cano 27  
Col San Miguel Chapultepec  
Mexico, D.F. 52760  
Tel: 01 (55) 2614 5211  
Fax: 01(55) 2614 9312  
info@plac.com.mx

**NEDERLAND**

VOLA Nederland BV  
Valkenburgerstraat 23  
1011 MG Amsterdam  
Tel: 020 36 56 356  
Fax: 020 36 56 482  
info.nl@vola.com  
www.vola.com

**NEW ZEALAND**

Metrix  
155 The Strand Parnell  
Auckland 1010  
P.O. Box 100-840  
NSMC 0745  
Tel: 09 379 7399  
Fax: 09 379 7035  
info@metrix.co.nz  
www.metrix.co.nz

**NIPPON**

Cera Trading Co.,Ltd  
TOTO Nogizaka BLDG.,1-24-3  
Minami Aoyama  
Minato-ku  
TOKYO 107-0062  
Tel: +81-3-3402-6151  
Fax: +81-3-3402-7185  
www.cera.co.jp

**NORGE**

VOLA Showroom  
shelby teknikk as  
Nedre Gate 7  
0551 Oslo  
Tel: +47 51 46 18 00  
post@shelby.no  
www.vola.com

shelby teknikk as  
Varbergveien 60  
4370 Egersund  
Tel: +47 51 46 18 00  
Fax: +47 51 46 18 01  
post@shelby.no  
www.shelby.no

**ÖSTERREICH**

VOLA Vertriebs GmbH  
Kandlgasse 19  
1070 Wien  
Tel: 01/526 39 71-0  
Fax: 01/526 39 71-20  
info@vola.at  
www.vola.at

**POLONIA**

PPU.H MIRAD Sp. z o.o.  
ul. Armii Krajowej 21  
05-480 Karczew, Poland  
Tel: 22 780 6564  
mirad@mirad.com.pl  
www.mirad.com.pl

**PORTUGAL**

CARVALHO, BATISTA & Ca, Sa.  
Rua da Almada  
29-79-89 - Apartado 4784  
4013-001 Porto  
Tel: 22 339 21 26 / 7 / 9  
Fax: 22 205 96 11  
carvalhobatista@mail.telepac.pt  
www.carvalhobatista.pt

**SCHWEIZ**

VOLA AG Bauarena  
Industriestrasse 18  
CH-8604 Volketswil  
Tel: 044 / 955 18 18  
Fax: 044 / 955 18 19  
sales@vola.ch  
www.vola.ch

VOLA Showroom  
Zürichbergstrasse 80  
8044 Zürich  
Tel: 044 / 955 18 18  
sales@vola.ch  
www.vola.ch

**SINGAPORE**

VolumeFive Pte Ltd.  
51 Anson Road,  
#01-53 Anson Centre,  
Singapore 079904  
Tel. +65 6348 2508  
Fax. +65 6348 2507  
sales@volumefivehome.com

**SLOVENIA**

Moderna d.o.o.  
Jarška cesta 10b  
SI-1000 Ljubljana  
Tel: +386 590 200 95  
Fax: +386 590 200 96  
info@moderna.si  
www.moderna.si

**SOUTH AFRICA**

Still the bathroom gallery  
Unit 111A, The Foundry  
74 Prestwich Str.  
Green Point Cape Town  
South Africa 8001  
Tel: 021 421 9970/2  
Tel: 021 421 9971  
info@stillbathrooms.co.za  
www.stillbathrooms.co.za

**SUOMI**

INNO-TUOTE OY  
Tähdälennantie 9  
02240 Espoo  
Tel: (0) 9 8870 380  
Fax: (0) 9 8870 3833  
info@inno.fi  
www.inno.fi

**SVERIGE**

VOLA AB Showroom  
Storgatan 24  
114 55 Stockholm  
Tel: +46 08-6602801  
sales@vola.se  
www.vola.se

**UNITED ARAB EMIRATES**

Sanipex LLC  
Sheik Zayed Road  
P.O. Box 30871  
Dubai  
Tel: 971 4 339 5660  
Fax: 971 4 339 5671  
www.sanipexdubai.com

**UNITED STATES**

Hastings Tile and Bath  
711-8 Koehler Avenue  
Ronkonkoma, N.Y. 11779  
Tel: 631-285-3330  
Fax: 631-285-3342  
vola@hastingstilebath.com  
www.hastingstilebath.com

